

FireBox M

Kabelabzweigkasten L - mit Funktionserhalt

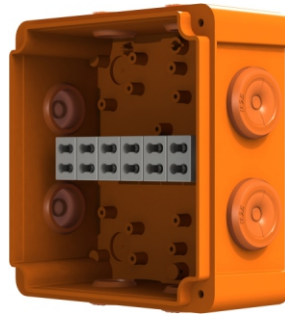

Klemmen horizontal

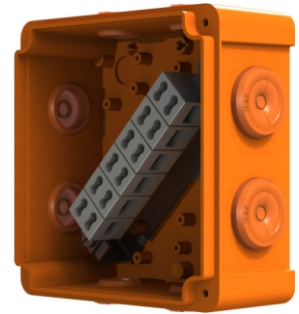

Klemmen diagonal

Sicherungshalter - Kabel bis max. 2,5mm²
SF0520-FB (Zubehör)

Set 2 Ankerschrauben - Beton
S2VAB-FB (Zubehör)

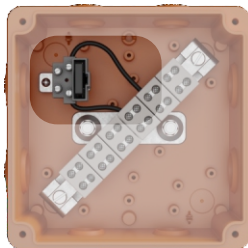

Für
Micro - Sicherungen
5x20 mm

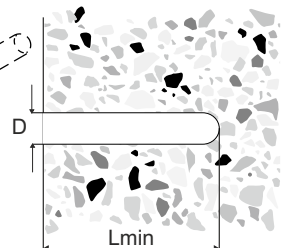
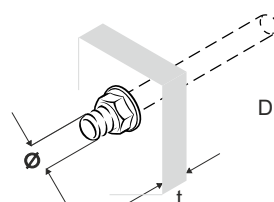
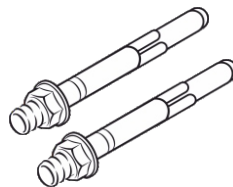

Abmessungen (mm)

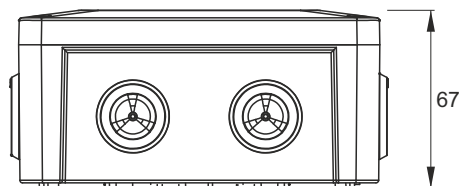
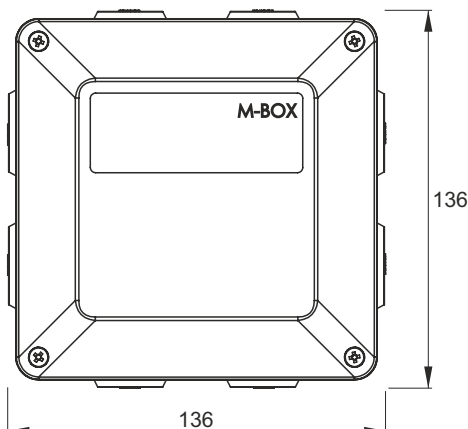

S2VAB-FB
Lmin : 40 mm
t : 0-30 mm
Ø : 6 mm
D : 6 mm

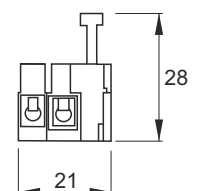
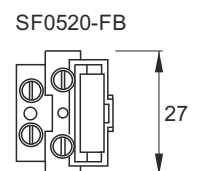
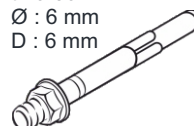

FireBox M

Kabelabzweigkasten L - mit Funktionserhalt



Technische Daten

Allgemein

Material	Halogenfreies Polycarbonat
Kabeleinführung	4x M20 und 4x M25
Temperaturbereich	-25 °C bis 55 °C
Norm(en)	DIN 4102-12
Zertifizierungs-Nr.	063-UWB-0306 von CNBOP-PIB-KOT-2020/0229-3704 1. Ausgabe vom 30.10.2020

Artikel

Typ	Artikel Nr.	Beschreibung	Funktions- erhalt	
	FSB002	2106 5002	6 -polig mit 4 Klemmen 6 mm ²	E90
	FSB005	2106 5005	8 -polig mit 2 Klemmen 4 mm ²	E90
	FSB008	2106 5008	5 -polig mit 2 Klemmen 10 mm ²	E90

FSB002

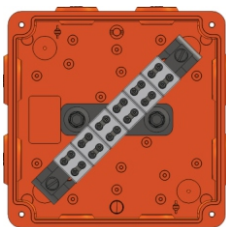

FSB005

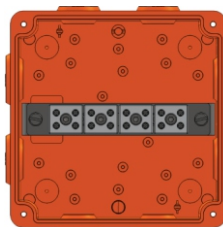

FSB008

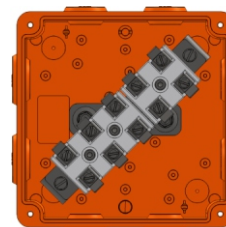

Zubehör

Set mit 2 Ankerschrauben



Typ	Artikel Nr.	Beschreibung
S2VAB-FB	2106 5050	Zur horizontalen oder vertikalen Montage in Beton oder Stein

L _{min}	: 40 mm	(Mindesttiefe)
t	: 0-30 mm	(Tiefe des Befestigungselement)
D	: 6 mm	(Lochdurchmesser)
Ø	: 6 mm	(Schraubendurchmesser)

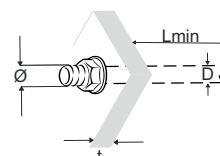

Sicherungshalter



Typ	Artikel Nr.	Beschreibung
PF0520-FB	2106 5060	Zum Schutz eines sekundären Abgangs, der sich in einem anderen Brandabschnitt befindet
Für Micro-Sicherungen 5x20 mm (0,5, 1, 2,5, 3,15 A) verdrahtet mit 2,5mm ²		

