

INFINI-S

Rettungszeichenleuchte gependelt - multifunktionell

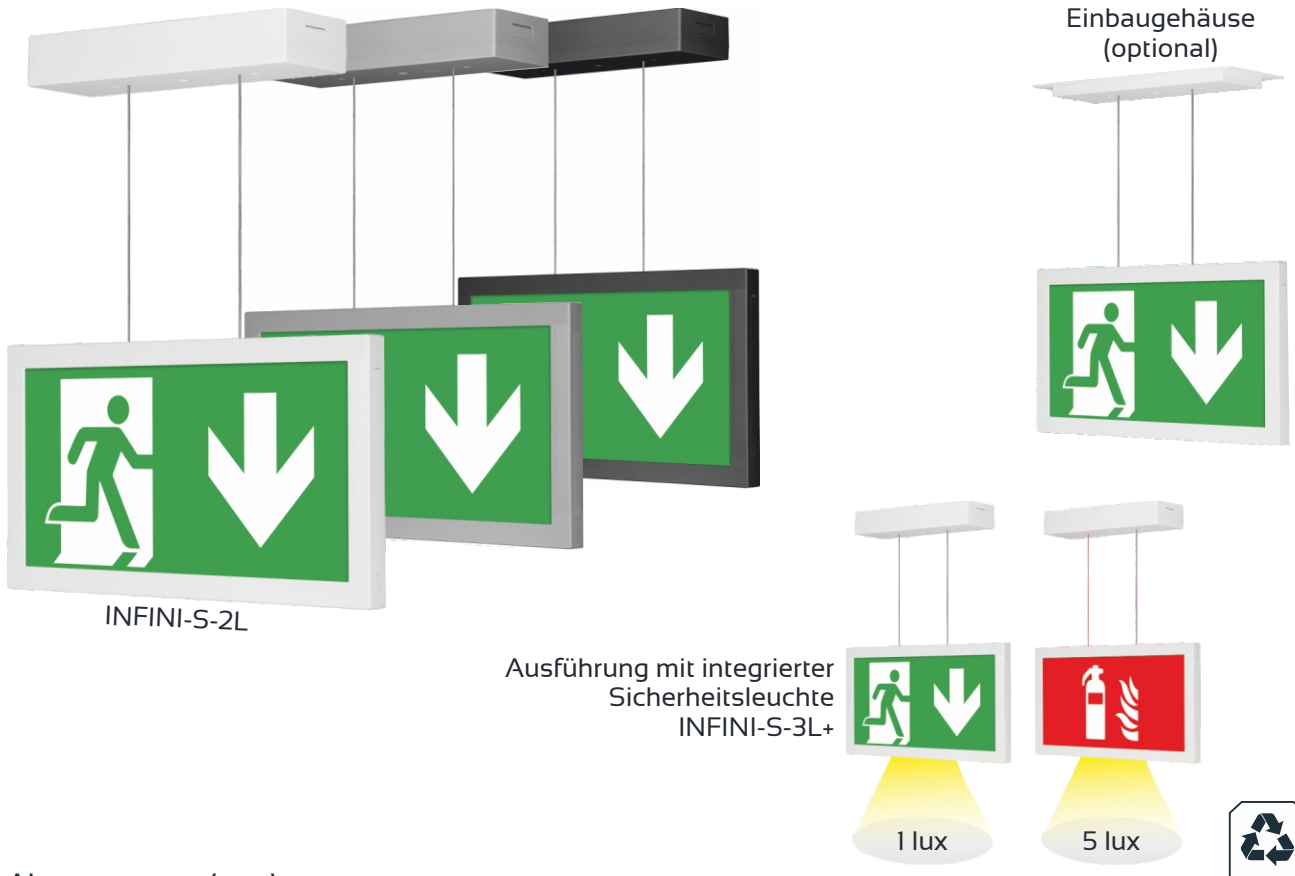

Garantie



Ausführung mit integrierter Sicherheitsleuchte
INFINI-S-3L+

Abmessungen (mm)

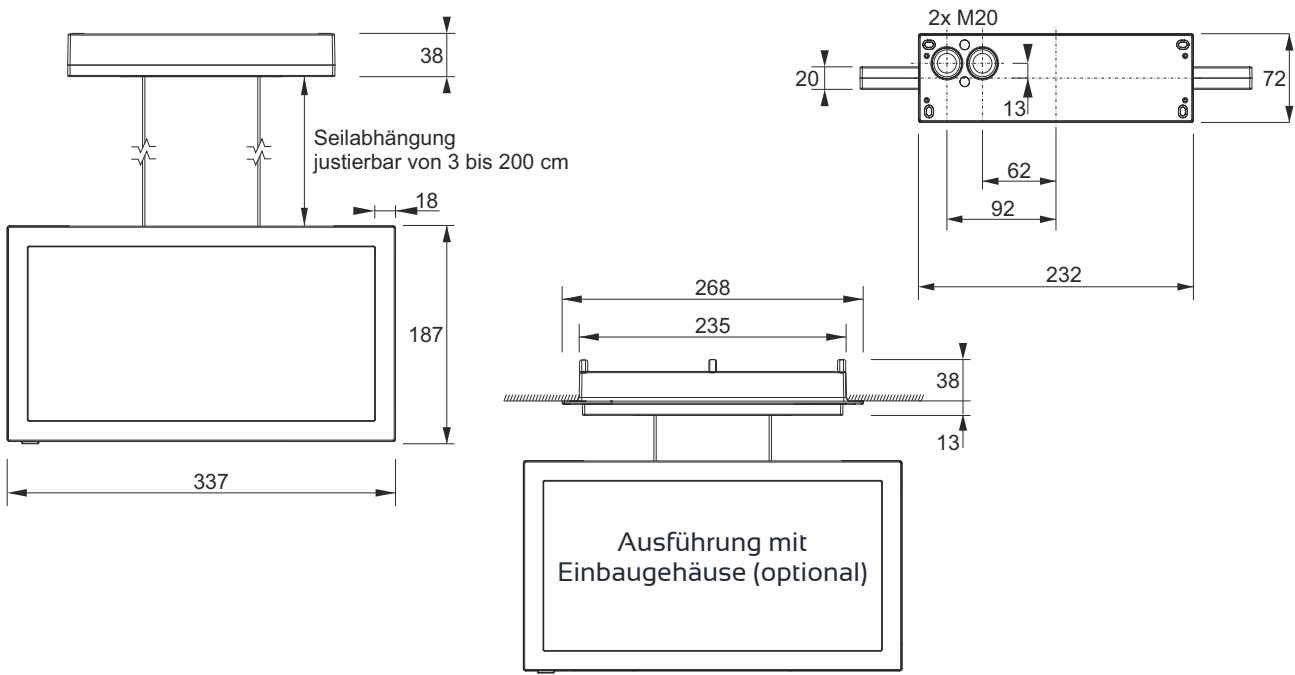

Rettungszeichenleuchte gependelt - multifunktionell



Technische Daten

Allgemein

Material	Polycarbonat
Leuchtmittel INFINI-S-2L	LED Steifen 2W / 270 lm / 6000 K / > 75'000 h
Leuchtmittel INFINI-S-3L+	LED Steifen 3W / 270 + 80 lm / 6000 K / > 75'000 h
Normen	SN-EN 1838, SN-EN 60598-2-22, SN-EN 61347-2-13, SN-EN 55015





Leuchten Zentralbatterie

24-48-230V

Temperaturbereich	-5 °C bis 40 °C
Spannung 230 V INFINI-S-2L	230 VAC ±10% 50-60 Hz - 6 VA / 220 VDC ±20% - 3,7 W
Spannung 230 V INFINI-S-3L+	230 VAC ±10% 50-60 Hz - 8 VA / 220 VDC ±20% - 4,8 W
Spannung 24V / 48V INFINI-S-2L	24 VDC ±20% ou 48 VDC ±20% / 3 W
Spannung 24V / 48V INFINI-S-3L+	24 VDC ±20% ou 48 VDC ±20% / 4 W
SMART TECHNOLOGY 	Adressierbar via PLC (Power line communication)
Gewicht	1,00 kg

Autonome Leuchten



Temperaturbereich	0 °C bis 40 °C
Spannung INFINI-S-2L	230 V ±10% 50-60 Hz - 1,9 à 8 VA max.
Spannung INFINI-S-3L+	230 V ±10% 50-60 Hz - 1,9 à 10 VA max.
Ladeteil / Ladezeit	PREMIUM 0,21 W / < 12 h
AUTOTEST 	Selbsttest Funktion und Autonomie
DALI 	Zentralisierte Kontrolle via DALI BUS / Einzelleuchtenadressierung
SMART TECHNOLOGY BUS 	Zentralisierte Kontrolle via BUS / Einzelleuchtenadressierung / System UNA
SMART TECHNOLOGY WIRELESS 	Zentralisierte Kontrolle via Funk/ Einzelleuchtenadressierung / System UNA
Batterie INFINI-S-2L	LiFePO ₄ 6,4 V / 1,0 Ah
Batterie INFINI-S-3L+	LiFePO ₄ 6,4 V / 1,5 Ah
Lichtstromfaktor Not / Autonomie	100% - 1h
Gewicht	1,10 kg

Fotometrische Daten

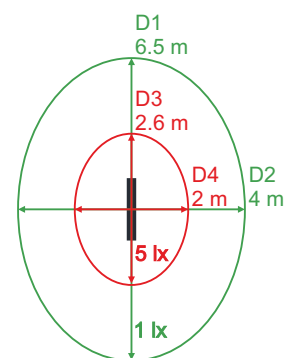
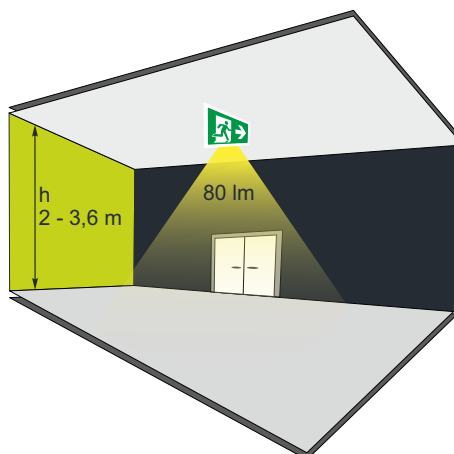
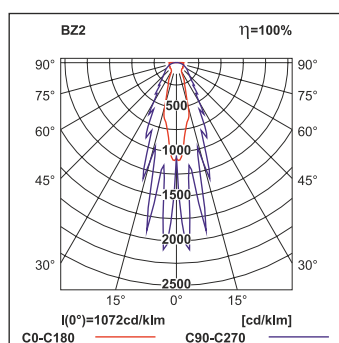

INFINI-S

Rettungszeichenleuchte gependelt - multifunktional



Garantie

Artikel

	Version	Typ	Artikel Nr.	Farbe
INFINI-S-3L+ 	AT	INFINI-S-3L+/ATPIL	2106 0651	RAL 9010
	CT	INFINI-S-3L+/CTPIL	2106 0651A	RAL 9010
	CTW	INFINI-S-3L+/CTWPIL	2106 0651W	RAL 9010
	DALI	INFINI-S-3L+/DAPIL	2106 0651D	RAL 9010
	230V^{AC/DC}	INFINI-S-3L+/230	2106 0652	RAL 9010
	230V^{AC/DC} AA	INFINI-S-3L+/AA230	2106 0652AA	RAL 9010
	24V^{DC} A	INFINI-S-3L+/A24	2106 0653	RAL 9010
	48V^{DC} A	INFINI-S-3L+/A48	2106 0654	RAL 9010

INFINI-S-2L 	AT	INFINI-S-2L/ATPIL	2106 0655	RAL 9010
	CT	INFINI-S-2L/CTPIL	2106 0655A	RAL 9010
	CTW	INFINI-S-2L/CTWPIL	2106 0655W	RAL 9010
	DALI	INFINI-S-2L/DAPIL	2106 0655D	RAL 9010
	230V^{AC/DC}	INFINI-S-2L/230	2106 0656	RAL 9010
	230V^{AC/DC} AA	INFINI-S-2L/AA230	2106 0656AA	RAL 9010
	24V^{DC} A	INFINI-S-2L/A24	2106 0657	RAL 9010
	48V^{DC} A	INFINI-S-2L/A48	2106 0658	RAL 9010

Auswahl Farbe	Type	Artikel Nr.	Farbe
Beispiel Grau	INFINI-S-_L/___-G	2106 065_-G	RAL 7045
Beispiel Schwarz	INFINI-S-_L/___-N	2106 065_-N	RAL 9005

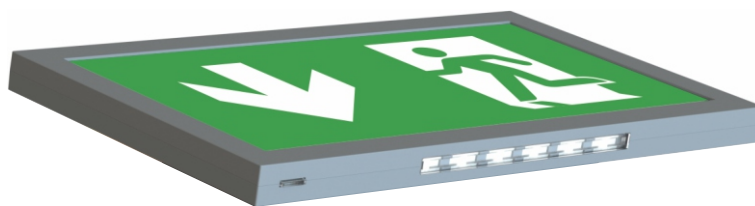

Rettungszeichenleuchte gependelt - multifunktionell









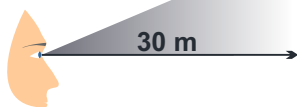

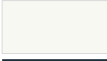









Zubehör Signalisation

Separat zu bestellen

Piktogramme
gemäss ISO 7010
300x150 mm



Symbole	Typ	Artikel Nr.	Symbole	Typ	Artikel Nr.
	PICF-INFINI-V.2	2106 0690		PICF-INFINI-NW	2106 0709
	PICF-INFINI-B.1	2106 0691		PICF-INFINI-E.2	2106 0711
	PICF-INFINI-H.1	2106 0693		PICF-INFINI-T.2	2106 0712
	PICF-INFINI-G.1	2106 0695		PICF-INFINI-ET.2	2106 0721
	PICF-INFINI-D.1	2106 0697		PICF-INFINI-PP.2	2106 0729
	PICF-INFINI-GH.1	2106 0701		PICF-INFINI-EP.2	2106 0731
	PICF-INFINI-GB.1	2106 0703		PICF-INFINI-BV.2	2106 0741
	PICF-INFINI-DH.1	2106 0705		PICF-INFINI-HV.2	2106 0742
	PICF-INFINI-DB.1	2106 0707		PICF-INFINI-GV.2	2106 0743
				PICF-INFINI-DV.2	2106 0744

Zubehör Einbau

Einbaugehäuse
Hohldecke / Wand

Material: Polycarbonat
Kalbeinführung Rohr : 2x M20
Montage : 2x Spannfedern

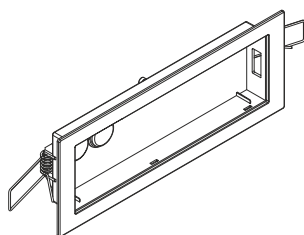

Typ	Artikel Nr.	Farbe
BE-INFINI	2106 0681	RAL 9010
BE-INFINI-G	2106 0681-G	RAL 7045
BE-INFINI-N	2106 0681-N	RAL 9005
Ausschnitt : 240 x 80 mm		
Einbautiefe : 95 mm minimum		

Betoneingiessgehäuse

Material : Inox
Kalbeinführung Rohr : 2x M20
Montage : Nageln oder vergiessen
Abmessungen : 256 x 76 x 41 mm

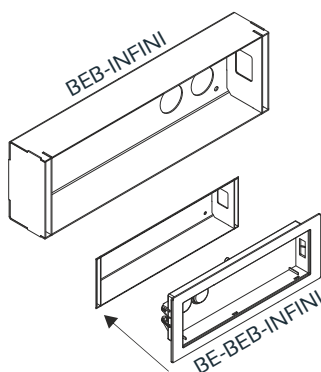

Typ	Artikel Nr.	Farbe
BEB-INFINI	2106 0682	INOX
BE-BEB-INFINI-B	2106 0682-B	RAL 9010
BE-BEB-INFINI-G	2106 0682-G	RAL 7045
BE-BEB-INFINI-N	2106 0682-N	RAL 9005