

INFINI-RL

Rettungszeichenleuchte Stromschiene - multifunktionell

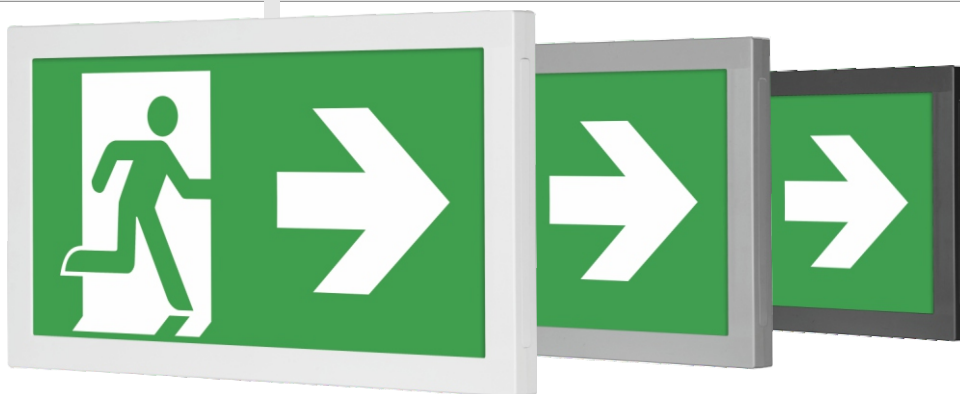

Ausführung mit integrierter Sicherheitsleuchte
INFINI-RL-3L+

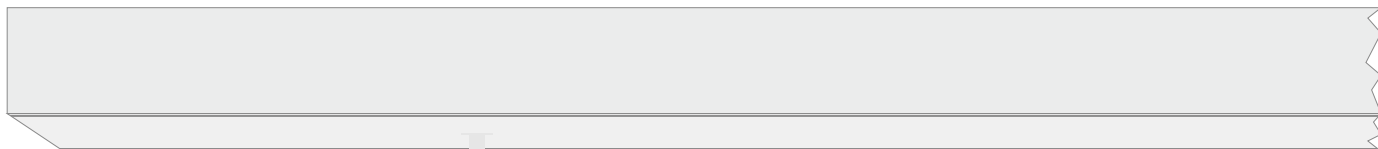

Abmessungen (mm)

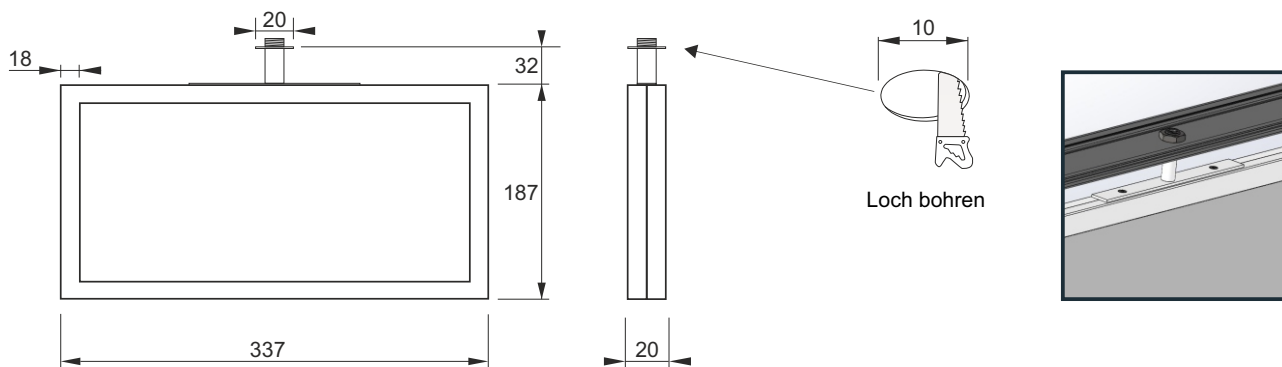

Komponenten zum Einbau Stromschiene

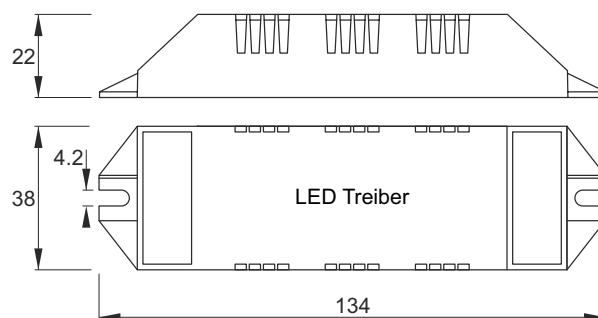
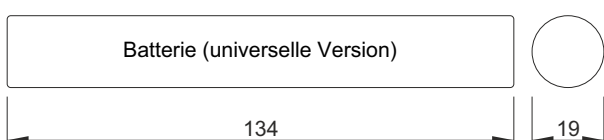

Rettungszeichenleuchte Stromschiene - multifunktionell



Technische Daten

Allgemein

Material	Polycarbonat
Leuchtmittel INFINI-RL-2L	LED Steifen 2W / 270 lm / 6000 K / > 75'000 h
Leuchtmittel INFINI-RL-3L+	LED Steifen 3W / 270 + 80 lm / 6000 K / > 75'000 h
Normen	SN-EN 1838, SN-EN 60598-2-22, SN-EN 61347-2-13, SN-EN 55015





Leuchten Zentralbatterie

24-48-230V

Temperaturbereich	-5 °C bis 40 °C
Spannung 230 V INFINI-RL-2L	230 VAC ±10% 50-60 Hz - 6 VA / 220 VDC ±20% - 3,7 W
Spannung 230 V INFINI-RL-3L+	230 VAC ±10% 50-60 Hz - 8 VA / 220 VDC ±20% - 4,8 W
Spannung 24V / 48V INFINI-RL-2L	24 VDC ±20% ou 48 VDC ±20% / 3 W
Spannung 24V / 48V INFINI-RL-3L+	24 VDC ±20% ou 48 VDC ±20% / 4 W
SMART TECHNOLOGY 	Adressierbar via PLC (Power line communication)
Gewicht	900 g

Autonome Leuchten



Temperaturbereich	0 °C bis 40 °C
Spannung INFINI-RL-2L	230 V ±10% 50-60 Hz - 1,9 à 8 VA max.
Spannung INFINI-RL-3L+	230 V ±10% 50-60 Hz - 1,9 à 10 VA max.
Ladeteil / Ladezeit	PREMIUM 0,21 W / < 12 h
AUTOTEST 	Selbsttest Funktion und Autonomie
DALI 	Zentralisierte Kontrolle via DALI BUS / Einzelleuchtenadressierung
SMART TECHNOLOGY BUS 	Zentralisierte Kontrolle via BUS / Einzelleuchtenadressierung / System UNA
SMART TECHNOLOGY WIRELESS 	Zentralisierte Kontrolle via Funk/ Einzelleuchtenadressierung / System UNA
Batterie INFINI-RL-2L	LiFePO ₄ 6,4 V / 1,0 Ah
Batterie INFINI-RL-3L+	LiFePO ₄ 6,4 V / 1,5 Ah
Lichtstromfaktor Not / Autonomie	100% - 1h
Gewicht	1,00 kg

Fotometrische Daten

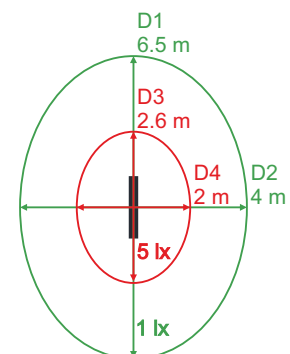
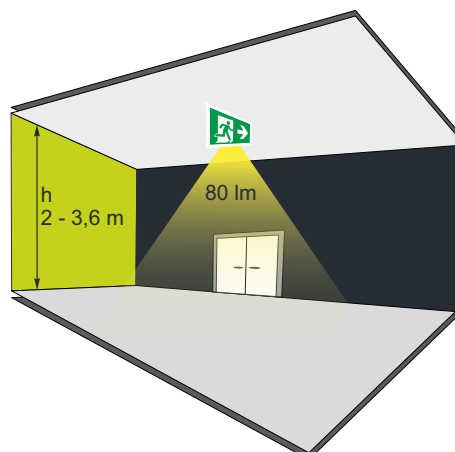
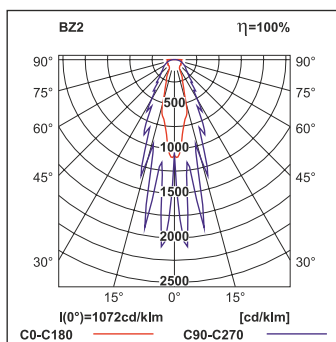

INFINI-RL

Rettungszeichenleuchte Stromschiene - multifunktionell



Garantie

Integrationsartikel

Leuchten

INFINI-RL-3L

INFINI-RL-2L



Typ	Artikel Nr.	Farbe
INFINI-RL-2L-B	2106 0621	RAL 9010
INFINI-RL-2L-G	2106 0621-G	RAL 7045
INFINI-RL-2L-N	2106 0621-N	RAL 9005
INFINI-RL-3L-B	2106 0622	RAL 9010
INFINI-RL-3L-G	2106 0622-G	RAL 7045
INFINI-RL-3L-N	2106 0622-N	RAL 9005

Module



Typ	Artikel Nr.	Technologie
ASL-3/ATPIL	2106 0135	AT
ASL-3/CTPIL	2106 0135A	CT
ASL-3/CTWPIL	2106 0135W	CTWP
ASL-3/DAPIL	2106 0135D	DALI
AL-3/230	2106 0163	230V^{AC/DC}
AL-3/AA230	2106 0162	230V^{AC/DC} AA
ALL-3/A24	2106 0151	24V^{DC} A
ALL-3/A48	2106 0157	48V^{DC} A

Zubehör Signalisation

Separat zu bestellen

Piktogramme
gemäss ISO 7010
300x150 mm

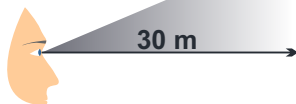

Symbole	Typ	Artikel Nr.	Symbole	Typ	Artikel Nr.
	PICF-INFINI-V.2	2106 0690		PICF-INFINI-NW	2106 0709
	PICF-INFINI-B.1	2106 0691		PICF-INFINI-E.2	2106 0711
	PICF-INFINI-H.1	2106 0693		PICF-INFINI-T.2	2106 0712
	PICF-INFINI-G.1	2106 0695		PICF-INFINI-ET.2	2106 0721
	PICF-INFINI-D.1	2106 0697		PICF-INFINI-PP.2	2106 0729
	PICF-INFINI-GH.1	2106 0701		PICF-INFINI-EPS.2	2106 0731
	PICF-INFINI-GB.1	2106 0703			
	PICF-INFINI-DH.1	2106 0705			
	PICF-INFINI-DB.1	2106 0707			









INFINI-RL









Rettungszeichenleuchte Stromschiene - multifunktionell



Garantie

Integration Module durch uns
(Adapter von 300 bis 600 mm exklusive)

	Version	Type	Artikel Nr.	Farbe
	 AT	IRL-INFINI-3L+/ATPIL	2150 0091	RAL 9010
	 CTPIL	IRL-INFINI-3L+/CTPIL	2150 0091A	RAL 9010
	 CTWPIL	IRL-INFINI-3L+/CTWPIL	2150 0091W	RAL 9010
	 DAPIL	IRL-INFINI-3L+/DAPIL	2150 0091D	RAL 9010
	230V ^{AC/DC}	IRL-INFINI-3L+/230	2150 0092	RAL 9010
	230V ^{AC/DC}  AA230	IRL-INFINI-3L+/AA230	2150 0092AA	RAL 9010
	24V ^{DC}  A24	IRL-INFINI-3L+/A24	2150 0093	RAL 9010
	48V ^{DC}  A48	IRL-INFINI-3L+/A48	2150 0094	RAL 9010

	 AT	IRL-INFINI-2L/ATPIL	2150 0095	RAL 9010
	 CTPIL	IRL-INFINI-2L/CTPIL	2150 0095A	RAL 9010
	 CTWPIL	IRL-INFINI-2L/CTWPIL	2150 0095W	RAL 9010
	 DAPIL	IRL-INFINI-2L/DAPIL	2150 0095D	RAL 9010
	230V ^{AC/DC}	IRL-INFINI-2L/230	2150 0096	RAL 9010
	230V ^{AC/DC}  AA230	IRL-INFINI-2L/AA230	2150 0096AA	RAL 9010
	24V ^{DC}  A24	IRL-INFINI-2L/A24	2150 0097	RAL 9010
	48V ^{DC}  A48	IRL-INFINI-2L/A48	2150 0098	RAL 9010

Auswahl Farbe	Typ	Artikel Nr.	Farbe
Beispiel Grau	IRL-INFINI-_L/___-G	2150 009_-G	RAL 7045
Beispiel Schwarz	IRL-INFINI-_L/___-N	2150 009_-N	RAL 9005

